



Use and Care Instructions

Pro-Power™ 12-Rack Dehydrator

Powerful • Large Capacity • Professional





1. Non-stick trays make clean-up easy
2. Digital temperature control for dehydrating a wide variety of foods
3. Handles are built-in for easy transport
4. LED interior lights and tempered glass window let you see the progress without opening the door

IMPORTANT SAFEGUARDS

WARNING:

When using any electrical appliance basic safety precautions should always be observed including the following:

- **READ ALL INSTRUCTIONS.**
-  To protect against risk of electrical shock, do not put appliance in water or other liquid.
-  Do not touch hot surfaces. Use handles, knobs or oven mitts.
- Close supervision is necessary when any appliance is used by or near children. This appliance is not recommended for use by children.
- Unplug from outlet when not in use, before putting on or taking off parts, and before cleaning.
- Allow to cool before putting on or taking off parts.
- Avoid contact with moving parts.
- Do not place on or near hot gas, electric burner or in a heated oven.
- Do not operate the appliance or any other electrical equipment with a damaged cord or plug or after the appliance malfunctions, is dropped or damaged in any manner. Return unit to the nearest authorized service center for examination, repair, or adjustment.
- Do not use outdoors.
- Do not use appliance for other than intended use.
- Do not let cord hang over edge of table or counter, contact sharp edges, or touch hot surfaces.
- Do not pull on the power cord to disconnect.
- Never plug in the appliance where water may flood the area.
- Place the appliance on a firm and stable surface.
- Ensure that the appliance is not placed close to the edge of the table, worktop, etc. where it can be pushed off or fall.
- The use of attachments not recommended or sold by the manufacturer may cause fire, electric shock or injury.
- Never use abrasive cleaning agents or abrasive cloths when cleaning the unit.
- Only use the unit when completely assembled.
- Do not leave the appliance unattended while it is running.
- Before using for the first time, remove all packaging and wash parts.
- To disconnect, turn control to "off", then remove plug from wall outlet.
- **CAUTION:** Turn unit on and off using timer or On/Off button only.

OVERVIEW OF COMPONENTS

1. Plastic Feet
2. Washer
3. Short Screw
4. Long Screws
5. Internal LED Lights
6. Tempered Glass Door
7. Rear Notched Trays
8. Center Hole Trays

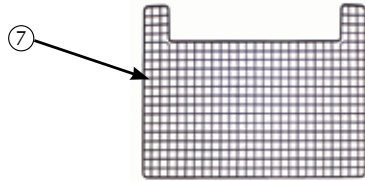
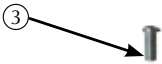
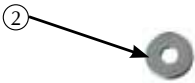
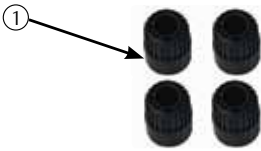

NOTE: Top three racks should be Rear Notched trays. The notched part lets more air around the sensor so the internal temperature is more accurate.

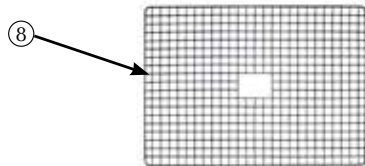

NOTE: Door will still close even though Center Hole trays are longer than Rear Notched trays.

NOTE: Before beginning assembly of product, make sure all parts are present. Compare parts with package contents list and hardware contents above. If any part is missing or damaged, DO NOT attempt to assemble the product. Contact Customer Service at **888-815-4252** for replace parts.

ASSEMBLY INSTRUCTIONS

CAUTION: BEFORE ASSEMBLING OR CLEANING THE DEHYDRATOR MAKE SURE POWER SWITCH IS TURNED OFF AND UNIT IS UNPLUGGED FROM ANY POWER SOURCE.

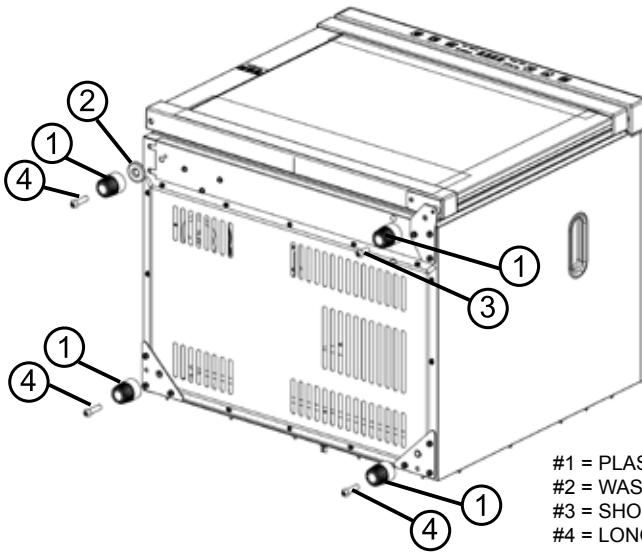

Assembly is a simple process.

This unit features feet that need to be attached.

1. Remove the drying racks and any loose items from the unit, then close the door.
2. Carefully place the dehydrator on its **LEFT SIDE**, on top of a soft cloth or surface to prevent any scratches. **NOTE: DO NOT PLACE ON THE RIGHT SIDE WHICH MAY CAUSE THE DOOR TO OPEN AND BECOME DAMAGED. DO NOT PLACE THE UNIT ON ITS FRONT OR BACK SIDE TO AVOID DAMAGING COMPONENTS.**
3. Using the diagram for reference, work on the front feet first. Locate the short screw (#3) and insert it through the foot (#1). This is for the foot under the door hinge. Tighten the foot onto the dehydrator with a screwdriver.
4. Use a long screw (#4) and the washer (#2) to secure the foot (#1) on the side on which the door opens.
5. Use the long screws (#4) to attach the back feet (#1) to the dehydrator.
6. Carefully stand the unit to its proper upright position, making sure to hold the door closed to avoid damaging it.

HOW TO USE YOUR NEW DEHYDRATOR

OPERATING INSTRUCTIONS:

1. Make sure to remove all packaging.
2. Wash and dry all parts prior to use.
3. Plug in unit. Exercise caution if using an extension cord.
4. Turn the power on by pushing the touch screen button located furthest right at the top panel.
5. Remove racks and place food items to be dried onto the racks.
6. Load the racks into the dehydrator. **NOTE:** The top three racks have a notch on the back to prevent the racks from touching the temperature sensor.
7. Make sure door is firmly closed.
- 8. NOTE:** THE BUTTON AT THE FURTHEST LEFT IS AN INTERNAL LIGHT FOR YOUR CONVENIENCE. Begin programming the unit by pressing the clock button located second from the furthest left of the panel. Use the UP “^” and DOWN “v” buttons on the right side of the panel to set hours of operation (24 Hour Maximum). Press the clock button a second time to set minutes if desired (1 minute increments).
9. To set the temperature, press the button located to the right of the clock button. Use the UP and DOWN buttons to set the temperature (160 degree max, 50 degree min, 5 degree increments).
10. The dehydrator will automatically start after a short delay. You will hear a beep at startup.
11. If you have to pause during programming, the unit may start after a delay. This is normal, just continue finishing your programming as soon as possible.
12. The unit automatically stops when time set has been reached, but the power to the unit remains on.
13. Push the on/off button to turn unit off and unplug when not in use.

EXTENSION CORD INSTRUCTIONS:

A short power supply cord should be used to reduce the risk of becoming entangled in or tripping over a longer cord. Extension cords are available and may be used if care is exercised in their use.

If an extension cord is used:

1. The marked electrical rating of the cord set or extension cord should be at least as great as the electrical rating of the appliance.
2. The cord should be arranged so that it will not drape over the countertop or tabletop where it can be pulled on by children or tripped over.
3. The extension cord should be a grounding type 3 wire cord.

HOW TO USE YOUR NEW DEHYDRATOR

OTHER FUNCTIONS:

This unit will automatically cycle through a display on the panel showing SET TIME, then TIME REMAINING for your drying, followed by the PRESET TEMPERATURE and then the ACTUAL TEMPERATURE inside the unit.

BEFORE YOUR FIRST USE:

Dehydrating is the process of removing moisture from food to create a food with increased longevity and stability.

HOW TO USE:

1. It is important to dry at the correct temperature for the item you are dehydrating because vitamins within food can react negatively to high temperatures. Thus, pay careful attention to your temperature settings when drying fruits, vegetables and meats.
2. To ensure consistent results always dry similar thickness items.
3. Use food that is ripe, but not over ripe.
4. Drying times will vary based on type and thickness of food being dried as well as the relative humidity of the environment you are drying in.
5. Your dehydrator has a clear front for easy observation of drying progress so avoid opening the dehydrator excessively during use. Doing so will add time to the drying process.
6. Once your food is dried to the desired level, store it in a sealed container in a cool, dry place so that it does not reabsorb moisture. The dehydrated food will naturally have less moisture in it than the air around it and will absorb moisture if left out for an extended period. **NOTE:** storing dried food in a freezer is acceptable and will prolong the life of the food.

NOTE: This unit operates most effectively when it is at least 2/3 full.

DRYING FRUIT:

1. You can dehydrate any fruit that you enjoy. Let your own taste buds determine what you choose to dry.
2. It is important to wash fruits thoroughly to make sure all dirt is removed.
3. You can halve, chop or slice your fruit. It is up to you whether you want to peel your fruit.
4. You may want to pretreat your fruit before drying it. Doing so will help prevent it from discoloring due to natural oxidation. To pretreat, simply use lemon or pineapple juice and mix with water at a 1:1 ratio. Let fruit sit in mixture for a minimum of 15 minutes. Then remove the fruit and let dry for at least one hour prior to drying. There are commercial products also available for pretreating.
5. Place fruit on the dehydrator trays in a single layer making sure that the fruit is not touching or overlapping.
6. Set temperature to 135° F .
7. Please reference the fruit drying guidelines chart on page 8 for recommended drying times.
8. Once the fruit is dried to your liking, let sit for at least 30 minutes to cool. Store in a covered or sealed container in a cool, dry place away from direct light.

HOW TO USE YOUR NEW DEHYDRATOR

DRYING JERKY:

Jerky is the most popular food to make in dehydrators. Making it yourself can save you money and allow you to create your own recipes. Use any lean meat you prefer such as beef, venison or fish.

SAFETY INFORMATION:

1. Sanitation and a clean working area are essential. Wash hands thoroughly with warm soapy water prior to making jerky.
2. Meat should be frozen or refrigerated up until it's ready to be used.
3. Do not allow raw meat to come in contact with the finished product.
4. Use a sanitizing solution or diluted bleach **to clean work surfaces only, when done.**
5. **DO NOT USE** diluted bleach for cleaning the dehydrator. For information on how to clean your dehydrator, **please see Page 10.**
6. If marinating meat for whole meat jerky, always marinate in the refrigerator.
7. We recommend that you purchase a pre-packaged jerky spice and cure kit. Follow the instructions for proper seasoning and curing.

PREPARING NATURAL JERKY:

1. Natural jerky is sliced from bigger pieces of meat. Make sure meat is in the freezer until it is slightly hard to the touch but NOT frozen. This will help it slice more evenly. For best results slice meat ¼" thick.
2. While there are many recipes for making your own jerky, we recommend using a pre-packaged jerky spice and cure kit. Follow the directions provided with the kit.
3. Place the meat on the drying racks making sure that they are not touching or overlapping.
4. Set temperature to 160° F.
5. Jerky typically takes 4-8 hours to dry properly.
6. When done drying, remove jerky from the trays and let cool for at least 30 minutes.
7. Use paper towels to remove any excess oil and fat that may be on the jerky.
8. Store in a covered or sealed container in a cool, dry place away from direct light.
9. If you would like to store your jerky for more than 1 month it is recommended that you store in a refrigerator or freezer.

PREPARING QUICK JERKY:

1. Quick jerky is made from ground meat. Use pre-packaged jerky spice and cure kit prior to drying and follow their instructions.
2. Once the mix is ready, place meat into jerky gun and carefully extrude the formed jerky strips making sure that the meat is not touching or overlapping. Jerky typically takes 4-8 hours to dry properly.
3. Set temperature to 160° F.
4. When the jerky is removed from the trays pat any excess oil or fat from the meat. Allow to cool for 30 minutes.
5. Store in a covered or sealed container in a cool, dry place away from direct light.
6. If you would like to store your jerky for more than 1 month it is recommended that you store in a refrigerator or freezer.

HOW TO USE YOUR NEW DEHYDRATOR

DRYING VEGETABLES:

Unlike other food, vegetables lose a lot of moisture towards the end of the process. Therefore, they must be checked constantly near the end of the drying process.

PREPARING VEGETABLES:

1. Thoroughly wash your vegetables to remove any dirt. Peel the vegetable and slice it into even sizes so that they dry at the same rate.
2. Pretreatment is necessary for all vegetables in order to neutralize their natural enzymes. Specifically, steam blanching is the preferred method. (See instructions on Page 10)
3. When you are done blanching, place the vegetables in cold water to cool them off.
4. Remove the vegetables from the water and dry them.
5. Place them in a single layer on the dehydrator trays making sure that they are neither touching or overlapping.
- 6. For Vegetables:** Set temperature to 130° F .
- 7. For Leafy Greens:** Set temperature to 105° F .
8. To determine if your vegetables are done drying, take out a few pieces from different racks in the dehydrator. If you cannot break the vegetable in half with little effort, place them back on the dehydrator for more time. Repeat the process until finished.
9. Once the vegetables are dried to your liking allow to cool for 30 minutes.
10. Store in a covered or sealed container in a cool, dry place away from direct light.

DRYING HERBS:

1. Drying your own herbs is an excellent way to save money and ensure you have a plentiful supply year round.
2. Once you select which herbs you want to dry, wash them in cool water to remove any dirt.
3. Lightly dry them off and place them on the dehydrator trays.
4. Set temperature to 105° F.
5. Drying time for herbs is 30-90 minutes. Therefore, make sure to constantly check herbs for dryness every fifteen minutes at a minimum. They are considered dry when you can easily crumble them in your fingers.
6. Once herbs are dried to your liking allow to cool for 30 minutes.
7. Store in a covered or sealed container in a cool, dry place away from direct light.

FRUIT DRYING GUIDE

Fruit	Preparation	*Pretreatment Necessary	Average Drying time
Kiwi	Peel and cut into 1/4" to 1/2" thick slices	No	2-6 hours
Pears	Peel, core and slice 1/8"	Yes	5-13 hours
Pineapple	Peel, core and slice 3/8"	No	4-12 hours
Strawberries	Remove top. Slice 3/8" thick	No	4-12 hours
Apples	Peel, if needed. Core, cut into slices, 1/8" to 1/4" thick	Yes	2-9 hours
Rhubarb	Trim and throw away leaves. Cut into 1/8" slices	No	4-9 hours
Peaches	Peel if needed. Cut and remove pit. Quarter or 3/8"	Yes	4-10 hours (slices) 8-16 hours (halves or quarters)
Cherries	Remove pit and stem. Cut, chop or leave whole	No	15-23 hours
Grapes	Cut in half or leave whole. Dry. Put in boiling water for 40 to 60 seconds. Put in ice water for skin to crack	No	13-21 hours
Prunes/Plums	Quarter or halve and discard pit	No	8-15 hours
Nectarines	Cut and remove pit. Quarter or slice 3/8" thick	Yes	5-10 hours (slices) 8-16 hours (halves or quarters)
Apricots	Slice in half, remove pit, and cut in 3/8" slices	Yes	8-16 hours
Blueberries	Remove stem. Put in boiling water for 40 to 60 seconds. Put in ice water for skin to crack	No	9-17 hours
Cranberries	Remove stem. Put in boiling water for 40 to 60 seconds. Put in ice water for skin to crack	No	10-18 hours
Bananas	Peel and cut into 1/4" to 3/8" slices	Yes	6-8 hours
Figs	Remove stem. Halve or quarter. Put whole figs in boiling water for 40 to 60 seconds. Put in ice water for skin to crack	No	8-15 hours

VEGETABLE DRYING GUIDE

Vegetable	Preparation	Steam Blanching Time	Average Drying time
Beets	Cook until tender, peel, cut into 1/4" thick strips	N/A	2-7 hours
Carrots	Peel and cut off each end, dice into 1/4" slices	2-2½ minutes	2-8 hours
Celery	Trim edges. Cut in 3/8" slices	3 minutes	3-5 hours
Onions	Peel outer skin. Cut off top and ends. Cut into 3/8" slices	N/A	3-7 hours
Tomatoes	Peel, if needed. Cut into slices 1/2" wide	N/A	4-11 hours
Potatoes	Peel and cut into 1/8" slices	5-9 minutes	2-8 hours
Peas	Shell	4 minutes	3-9 hours
Corn	Cut corn from cob and blanch	1-1½ minutes	5-11 hours
Broccoli	Cut in pieces	2-2½ minutes	2-8 hours
Mushrooms	Clean and slice 1/2" thick	N/A	3-7 hours
Peppers and Pimientos	Remove core, stem, and inner partitions cut into 1/8" strips	N/A	4-10 hours
Cauliflower	Cut in pieces	3-6 minutes	3-8 hours
Green/wax beans	Take off ends and strings. Cut in 3/4" to 1" pieces	3-3½ minutes	4-11 hours
Summer squash and zucchini	Cut ends. Cut into 3/8" wide	3½-4 minutes	2-6 hours
Asparagus	Cut in 3/4" to 1" pieces	3-5 minutes	4-8 hours

VEGETABLE DRYING GUIDE

STEAM BLANCHING ON THE STOVE:

Stainless steel or bamboo steaming baskets can be found at most department stores or thrift stores. These are highly recommended. Steamer pans will also work.

1. Choose a sauce pan that comfortably fits your steaming basket with the lid on.
2. Place an inch or two of water in the bottom of the pan and bring to a full boil.
3. Add the steamer basket containing your prepared vegetables or fruit and cover the pan tightly with the lid.
4. Carefully time your blanching per recipe so as not to over-cook your produce. As a rule of thumb, this will be about half of the cooking time as you would normally use to fully cook the vegetables.
5. As soon as the food has been steamed for the recommended time, immediately remove it from the heat, and run cool water over it to stop it from cooking any further.

STEAM BLANCHING IN THE MICROWAVE:

Steam blanching in the microwave is quick and easy. You will just need a microwave-safe dish with a lid (a bowl with a plate over the top will usually do the trick).

1. Wash, peel, and slice the vegetables or fruit as desired for drying.
2. Place the vegetables in a microwave-safe bowl and add a splash of water.
3. Cover the bowl with a microwave-safe lid or plate, and microwave on high for half the time it would take to fully cook the vegetables in the microwave. Pause the microwave once or twice to stir the vegetables or fruit to ensure even cooking.
4. When cooking is finished, immediately rinse the vegetables or fruit under cool running water to halt the cooking.

HOW TO CLEANING YOUR DEHYDRATOR

CLEANING AND MAINTENANCE:

1. Before cleaning, dehydrator **must** be unplugged and cooled down.
2. Thoroughly wash trays with **warm soapy water and dry completely. DO NOT submerge base in water. DO NOT let water get in fan.**
3. Do not use metal brushes or abrasive cleaners when cleaning the dehydrator, because it can damage the surface.



© 2015 Chard International, P.O. Box 444, Two Rivers, WI 54241-0444 1-888-815-4252

WARRANTY

Your product is warranted for one year from date of purchase against all defects in material and workmanship. Should your product prove defective within one year from date of purchase or receipt, return the unit, freight prepaid, along with an explanation of the claim. Please package your product carefully in its original box and packing material to avoid damage in transit. (We are not responsible for any damage caused to the product in return shipment.) Under this warranty, we undertake to repair or replace any parts found to be defective.

This warranty is only valid if the product is used solely in accordance with the instructions. This warranty is invalid if the unit is connected to an unsuitable electrical supply, or dismantled or interfered with in any way or damaged through misuse.

We ask that you kindly fill in the details on your warranty card and return it within one week from date of purchase. **Send warranty card to:**

CD80C / Pro-PowerTM 12-Rack Dehydrator

C/O CI

PO Box 444

Two Rivers, WI 54241-0444